



## VÁLVULAS GLOBO TIPO PONTA DE AGULHA



Características		
	<b>1 - Corpo</b>	Tarugo de aço trefilado em SAE 1020 com tratamento superficial anti-corosivo, Inox AISI 304 ou AISI 316.
	<b>2 - Castelo</b>	Aço trefilado em SAE 1020 com tratamento superficial anti-corosivo Inox AISI 304 ou AISI 316.
	<b>3 - Calço</b>	Aço trefilado em SAE 1020 com tratamento superficial anti-corosivo Inox AISI 304 ou AISI 316.
	<b>4 - Gaxeta</b>	Teflon (PTFE) puro ou Graflex ( para alta temperatura).
	<b>5 - Aperta gaxeta</b>	Aço trefilado em SAE 1020 com tratamento superficial anti-corosivo, Inox AISI 304.
	<b>6 - Porca</b>	Aço Trefilado em SAE 1020 com tratamento superficial anti-corosivo, Inox AISI 304.
	<b>7 - Haste</b>	Aço trefilado solubilizado em Inox AISI 420, 304 ou 316.
	<b>8 - Manípulo</b>	Aço trefilado em SAE 1020 com tratamento superficial anti-corosivo Inox AISI 420.

- Teste Hidrostático em todas as Válvulas após a montagem.
- Opcionalmente aplicação de Stellite na Sede ou Agulha.

LEGENDA DAS SIGLAS	
VACF	Válvula <b>A</b> gulha Aço <b>C</b> arbono <b>F</b> êmea
VAIF	Válvula <b>A</b> gulha Aço <b>I</b> nox <b>304</b> <b>F</b> êmea
VAYF	Válvula <b>A</b> gulha Aço <b>I</b> nox <b>316</b> <b>F</b> êmea
VACM	Válvula <b>A</b> gulha Aço <b>C</b> arbono <b>M</b> acho
VAIOD	Válvula <b>A</b> gulha Aço <b>I</b> nox <b>304</b> tubo <b>OD</b>



## VÁLVULAS GLOBO TIPO PONTA DE AGULHA

Série 3000 -Classe de Pressão : Óleo, Água e Gás à 40°C -3000lbs ou 210kg/m<sup>2</sup>

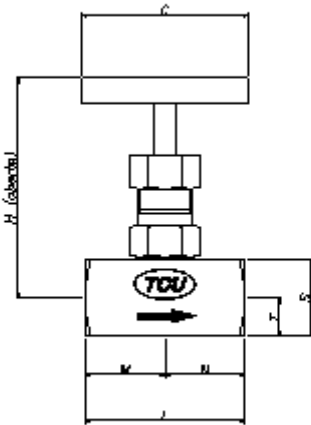

Dimensões- Modelos de Conexões Fêmea ( VACF/VAIF/VAYF)

Código	Passagem	Conexões		C	H	L	M	N	S	T	CV	Peso (kg)
	Efetiva (mm)	Entrada	Saída									
VACF/VAIF/VAYF 1/8" NPT	3,0	1/8" NPT	1/8" NPT	70	79,0	47,5	23,75	23,75	25,40	12,70	0,19	0,370
VACF/VAIF/VAYF 1/8" BSP	3,0	1/8" BSP	1/8" BSP	70	79,0	47,5	23,75	23,75	25,40	12,70	0,19	0,370
VACF/VAIF/VAYF 1/8" SW	3,0	1/8" SW	1/8" SW	70	79,0	47,5	23,75	23,75	25,40	12,70	0,19	0,370
VACF/VAIF/VAYF 1/4" NPT	4,5	1/4" NPT	1/4" NPT	70	79,0	47,5	23,75	23,75	25,40	12,70	0,43	0,350
VACF/VAIF/VAYF 1/4" BSP	4,5	1/4" BSP	1/4" BSP	70	79,0	47,5	23,75	23,75	25,40	12,70	0,43	0,350
VACF/VAIF/VAYF 1/4" SW	4,5	1/4" SW	1/4" SW	70	79,0	47,5	23,75	23,75	25,40	12,70	0,43	0,350
VACF/VAIF/VAYF 3/8" NPT	5,5	3/8" NPT	3/8" NPT	70	79,0	47,5	23,75	23,75	25,40	12,70	0,65	0,325
VACF/VAIF/VAYF 3/8" BSP	5,5	3/8" BSP	3/8" BSP	70	79,0	47,5	23,75	23,75	25,40	12,70	0,65	0,325
VACF/VAIF/VAYF 3/8" SW	5,5	3/8" SW	3/8" SW	70	79,0	47,5	23,75	23,75	25,40	12,70	0,65	0,325
VACF/VAIF/VAYF 1/2" NPT	7,0	1/2" NPT	1/2" NPT	70	83,0	60,0	30,00	30,00	28,57	14,28	1,03	0,450
VACF/VAIF/VAYF 1/2" BSP	7,0	1/2" BSP	1/2" BSP	70	83,0	60,0	30,00	30,00	28,57	14,28	1,03	0,450
VACF/VAIF/VAYF 1/2" SW	7,0	1/2" SW	1/2" SW	70	83,0	60,0	30,00	30,00	28,57	14,28	1,03	0,450
VACF/VAIF/VAYF 3/4" NPT	8,5	3/4" NPT	3/4" NPT	70	97,5	70,0	35,00	35,00	38,10	19,05	1,4	0,850
VACF/VAIF/VAYF 3/4" BSP	8,5	3/4" BSP	3/4" BSP	70	97,5	70,0	35,00	35,00	38,10	19,05	1,4	0,850
VACF/VAIF/VAYF 3/4" SW	8,5	3/4" SW	3/4" SW	70	97,5	70,0	35,00	35,00	38,10	19,05	1,4	0,850
VACF/VAIF/VAYF 1" NPT	11,0	1" NPT	1" NPT	90	126,0	89,0	44,50	44,50	50,80	25,40	2,4	1,090
VACF/VAIF/VAYF 1" BSP	11,0	1" BSP	1" BSP	90	126,0	89,0	44,50	44,50	50,80	25,40	2,4	1,090
VACF/VAIF/VAYF 1" SW	11,0	1" SW	1" SW	90	126,0	89,0	44,50	44,50	50,80	25,40	2,4	1,090
VACF/VAIF/VAYF 1.1/2" NPT	16,0	1.1/2" NPT	1.1/2" NPT	105	132,0	104,0	56,00	56,00	63,50	31,75	5,0	2,900
VACF/VAIF/VAYF 1.1/2" BSP	16,0	1.1/2" BSP	1.1/2" BSP	105	132,0	104,0	56,00	56,00	63,50	31,75	5,0	2,900
VACF/VAIF/VAYF 1.1/2"SW	16,0	1.1/2"SW	1.1/2"SW	105	132,0	104,0	56,00	56,00	63,50	31,75	5,0	2,900



## VÁLVULAS GLOBO TIPO PONTA DE AGULHA

Série 3000 -Classe de Pressão : Óleo, Água e Gás à 40 °C -3000lbs ou 210kg/m<sup>2</sup>

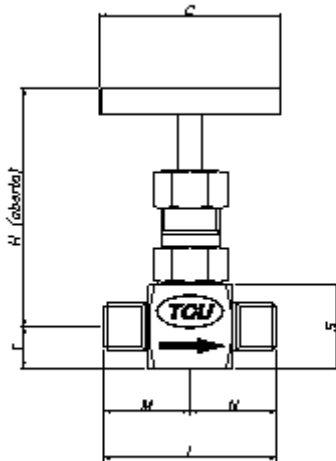

Conexões Macho ( VACM/VAIM/VAYM)

Código	Passagem	Conexões		C	H	L	M	N	S	T	CV	Peso (kg)
	Efetiva (mm)	Entrada	Saída									
VACM/VAIM/VAYM 1/4" NPT	4,5	1/4" NPT	1/4" NPT	70	79,0	51,0	25,50	25,50	25,40	12,70	0,43	0,315
VACM/VAIM/VAYM 1/4" BSP	4,5	1/4" BSP	1/4" BSP	70	79,0	51,0	25,50	25,50	25,40	12,70	0,43	0,315
VACM/VAIM/VAYM 3/8" NPT	5,5	3/8" NPT	3/8" NPT	70	79,0	51,0	25,50	25,50	25,40	12,70	0,65	0,340
VACM/VAIM/VAYM 3/8" BSP	5,5	3/8" BSP	3/8" BSP	70	79,0	51,0	25,50	25,50	25,40	12,70	0,65	0,340
VACM/VAIM/VAYM 1/2" NPT	7,0	1/2" NPT	1/2" NPT	70	83,0	60,0	30,00	30,00	28,57	14,28	1,03	0,420
VACM/VAIM/VAYM 1/2" BSP	7,0	1/2" BSP	1/2" BSP	70	83,0	60,0	30,00	30,00	28,57	14,28	1,03	0,420
VACM/VAIM/VAYM 3/4" NPT	8,5	3/4" NPT	3/4" NPT	70	97,5	70,0	35,00	35,00	38,10	19,05	1,4	0,820
VACM/VAIM/VAYM 3/4" BSP	8,5	3/4" BSP	3/4" BSP	70	97,5	70,0	35,00	35,00	38,10	19,05	1,4	0,820
VACM/VAIM/VAYM 1" NPT	11,0	1" NPT	1" NPT	90	126,0	89,0	44,50	44,50	50,80	25,40	2,4	1,00
VACM/VAIM/VAYM 1" BSP	11,0	1" BSP	1" BSP	90	126,0	89,0	44,50	44,50	50,80	25,40	2,4	1,00
VACM/VAIM/VAYM 1.1/2" NPT	16,0	1.1/2" NPT	1.1/2" NPT	105	132,0	104,0	56,00	56,00	63,50	31,75	5,0	2,800
VACM/VAIM/VAYM 1.1/2" BSP	16,0	1.1/2" BSP	1.1/2" BSP	105	132,0	104,0	56,00	56,00	63,50	31,75	5,0	2,800



## VÁLVULAS GLOBO TIPO PONTA DE AGULHA

Série 3000 -Classe de Pressão : Óleo, Água e Gás à 40 °C -3000lbs ou 210kg/m<sup>2</sup>

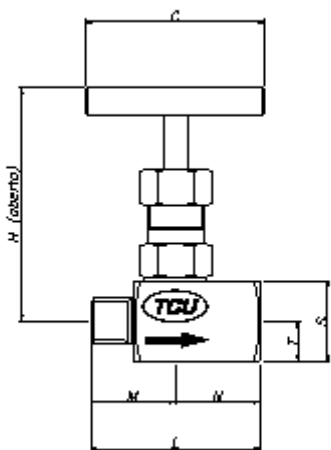

Conexões Macho/Fêmea  
(VACMF/VAIMF/VAYMF)

Código	Passagem	Conexões		C	H	L	M	N	S	T	CV	Peso (kg)
	Efetiva (mm)	Entrada	Saída									
VACMF/VAIMF/VAYMF 1/4" NPT	4,5	1/4" NPT	1/4" NPT	70	79,0	49,5	25,75	23,75	25,40	12,70	0,43	0,350
VACMF/VAIMF/VAYMF 1/4" BSP	4,5	1/4" BSP	1/4" BSP	70	79,0	49,5	25,75	23,75	25,40	12,70	0,43	0,350
VACMF/VAIMF/VAYMF 1/4" SW	4,5	1/4" NPT	1/4" SW	70	79,0	49,5	25,75	23,75	25,40	12,70	0,43	0,350
VACMF/VAIMF/VAYMF 3/8" NPT	5,5	3/8" NPT	3/8" NPT	70	79,0	49,5	25,75	23,75	25,40	12,70	0,65	0,325
VACMF/VAIMF/VAYMF 3/8" BSP	5,5	3/8" BSP	3/8" BSP	70	79,0	49,5	25,75	23,75	25,40	12,70	0,65	0,325
VACMF/VAIMF/VAYMF 3/8" SW	5,5	3/8" NPT	3/8" SW	70	79,0	49,5	25,75	23,75	25,40	12,70	0,65	0,325
VACMF/VAIMF/VAYMF 1/2" NPT	7,0	1/2" NPT	1/2" NPT	70	83,0	60,0	30,00	30,00	28,57	14,28	1,03	0,450
VACMF/VAIMF/VAYMF 1/2" BSP	7,0	1/2" BSP	1/2" BSP	70	83,0	60,0	30,00	30,00	28,57	14,28	1,03	0,450
VACMF/VAIMF/VAYMF 1/2" SW	7,0	1/2" NPT	1/2" SW	70	83,0	60,0	30,00	30,00	28,57	14,28	1,03	0,450
VACMF/VAIMF/VAYMF 3/4" NPT	8,5	3/4" NPT	3/4" NPT	70	97,5	70,0	35,00	35,00	38,10	19,05	1,4	0,850
VACMF/VAIMF/VAYMF 3/4" BSP	8,5	3/4" BSP	3/4" BSP	70	97,5	70,0	35,00	35,00	38,10	19,05	1,4	0,850
VACMF/VAIMF/VAYMF 3/4" SW	8,5	3/4" NPT	3/4" SW	70	97,5	70,0	35,00	35,00	38,10	19,05	1,4	0,850
VACMF/VAIMF/VAYMF 1" NPT	11,0	1" NPT	1" NPT	90	126,0	89,0	44,50	44,50	50,80	25,40	2,4	1,090
VACMF/VAIMF/VAYMF 1" BSP	11,0	1" BSP	1" BSP	90	126,0	89,0	44,50	44,50	50,80	25,40	2,4	1,090
VACMF/VAIMF/VAYMF 1" SW	11,0	1" NPT	1" SW	90	126,0	89,0	44,50	44,50	50,80	25,40	2,4	1,090
VACMF/VAIMF/VAYMF 1.1/2" NPT	16,0	1.1/2" NPT	1.1/2" NPT	105	132,0	104,0	56,00	56,00	63,50	31,75	5,0	2,900
VACMF/VAIMF/VAYMF 1.1/2" BSP	16,0	1.1/2" BSP	1.1/2" BSP	105	132,0	104,0	56,00	56,00	63,50	31,75	5,0	2,900
VACMF/VAIMF/VAYMF 1.1/2" SW	16,0	1.1/2" NPT	1.1/2" SW	105	132,0	104,0	56,00	56,00	63,50	31,75	5,0	2,900



## VÁLVULAS GLOBO TIPO PONTA DE AGULHA

Série 6000 -Classe de Pressão : Óleo, Água e Gás à 40°C -6000lbs ou 420kg/m<sup>2</sup>

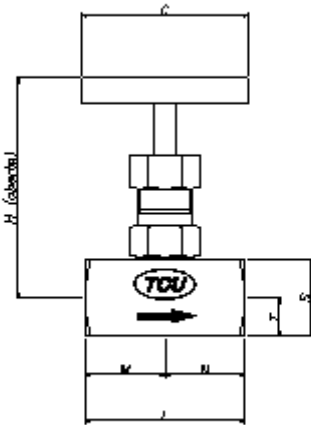

Dimensões- Modelos de Conexões Fêmea ( VACF/VAIF/VAYF)

Código	Passagem	Conexões		C	H	L	M	N	S	T	CV	Peso (kg)
	Efetiva (mm)	Entrada	Saída									
VACF/VAIF/VAYF 1/8" NPT	3,0	1/8" NPT	1/8" NPT	70	82,0	47,5	23,75	23,75	28,57	14,28	0,19	0,470
VACF/VAIF/VAYF 1/8" BSP	3,0	1/8" BSP	1/8" BSP	70	82,0	47,5	23,75	23,75	28,57	14,28	0,19	0,470
VACF/VAIF/VAYF 1/8" SW	3,0	1/8" SW	1/8" SW	70	82,0	47,5	23,75	23,75	28,57	14,28	0,19	0,470
VACF/VAIF/VAYF 1/4" NPT	4,5	1/4" NPT	1/4" NPT	70	82,0	47,5	23,75	23,75	28,57	14,28	0,43	0,430
VACF/VAIF/VAYF 1/4" BSP	4,5	1/4" BSP	1/4" BSP	70	82,0	47,5	23,75	23,75	28,57	14,28	0,43	0,430
VACF/VAIF/VAYF 1/4" SW	4,5	1/4" SW	1/4" SW	70	82,0	47,5	23,75	23,75	28,57	14,28	0,43	0,430
VACF/VAIF/VAYF 3/8" NPT	5,5	3/8" NPT	3/8" NPT	70	82,0	47,5	23,75	23,75	28,57	14,28	0,65	0,390
VACF/VAIF/VAYF 3/8" BSP	5,5	3/8" BSP	3/8" BSP	70	82,0	47,5	23,75	23,75	28,57	14,28	0,65	0,390
VACF/VAIF/VAYF 3/8" SW	5,5	3/8" SW	3/8" SW	70	82,0	47,5	23,75	23,75	28,57	14,28	0,65	0,390
VACF/VAIF/VAYF 1/2" NPT	7,0	1/2" NPT	1/2" NPT	70	86,5	60,0	30,00	30,00	31,75	15,87	1,03	0,545
VACF/VAIF/VAYF 1/2" BSP	7,0	1/2" BSP	1/2" BSP	70	86,5	60,0	30,00	30,00	31,75	15,87	1,03	0,545
VACF/VAIF/VAYF 1/2" SW	7,0	1/2" SW	1/2" SW	70	86,5	60,0	30,00	30,00	31,75	15,87	1,03	0,545
VACF/VAIF/VAYF 3/4" NPT	8,5	3/4" NPT	3/4" NPT	70	99,0	70,0	35,00	35,00	41,27	20,63	1,4	0,980
VACF/VAIF/VAYF 3/4" BSP	8,5	3/4" BSP	3/4" BSP	70	99,0	70,0	35,00	35,00	41,27	20,63	1,4	0,980
VACF/VAIF/VAYF 3/4" SW	8,5	3/4" SW	3/4" SW	70	99,0	70,0	35,00	35,00	41,27	20,63	1,4	0,980
VACF/VAIF/VAYF 1" NPT	11,0	1" NPT	1" NPT	90	126,0	89,0	44,50	44,50	50,80	25,40	2,4	1,090
VACF/VAIF/VAYF 1" BSP	11,0	1" BSP	1" BSP	90	126,0	89,0	44,50	44,50	50,80	25,40	2,4	1,090
VACF/VAIF/VAYF 1" SW	11,0	1" SW	1" SW	90	126,0	89,0	44,50	44,50	50,80	25,40	2,4	1,090
VACF/VAIF/VAYF 1.1/2" NPT	16,0	1.1/2" NPT	1.1/2" NPT	105	132,0	104,0	56,00	56,00	63,50	31,75	5,0	2,900
VACF/VAIF/VAYF 1.1/2" BSP	16,0	1.1/2" BSP	1.1/2" BSP	105	132,0	104,0	56,00	56,00	63,50	31,75	5,0	2,900
VACF/VAIF/VAYF 1.1/2"SW	16,0	1.1/2"SW	1.1/2"SW	105	132,0	104,0	56,00	56,00	63,50	31,75	5,0	2,900



## VÁLVULAS GLOBO TIPO PONTA DE AGULHA

Série 6000 -Classe de Pressão : Óleo, Água e Gás à 40 °C -6000lbs ou 420kg/m<sup>2</sup>

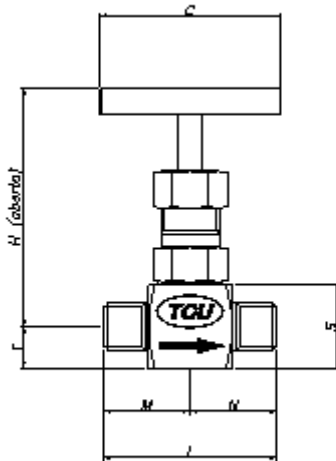

Conexões Macho ( VACM/VAIM/VAYM)

Código	Passagem	Conexões		C	H	L	M	N	S	T	CV	Peso (kg)
	Efetiva (mm)	Entrada	Saída									
VACM/VAIM/VAYM 1/4" NPT	4,5	1/4" NPT	1/4" NPT	70	79,0	51,0	25,50	25,50	28,57	14,28	0,43	0,400
VACM/VAIM/VAYM 1/4" BSP	4,5	1/4" BSP	1/4" BSP	70	79,0	51,0	25,50	25,50	28,57	14,28	0,43	0,400
VACM/VAIM/VAYM 3/8" NPT	5,5	3/8" NPT	3/8" NPT	70	79,0	51,0	25,50	25,50	28,57	14,28	0,65	0,375
VACM/VAIM/VAYM 3/8" BSP	5,5	3/8" BSP	3/8" BSP	70	79,0	51,0	25,50	25,50	28,57	14,28	0,65	0,375
VACM/VAIM/VAYM 1/2" NPT	7,0	1/2" NPT	1/2" NPT	70	83,0	60,0	30,00	30,00	31,75	15,87	1,03	0,515
VACM/VAIM/VAYM 1/2" BSP	7,0	1/2" BSP	1/2" BSP	70	83,0	60,0	30,00	30,00	31,75	15,87	1,03	0,515
VACM/VAIM/VAYM 3/4" NPT	8,5	3/4" NPT	3/4" NPT	70	97,5	70,0	35,00	35,00	41,27	20,63	1,4	0,950
VACM/VAIM/VAYM 3/4" BSP	8,5	3/4" BSP	3/4" BSP	70	97,5	70,0	35,00	35,00	41,27	20,63	1,4	0,950
VACM/VAIM/VAYM 1" NPT	11,0	1" NPT	1" NPT	90	126,0	89,0	44,50	44,50	50,80	25,40	2,4	1,00
VACM/VAIM/VAYM 1" BSP	11,0	1" BSP	1" BSP	90	126,0	89,0	44,50	44,50	50,80	25,40	2,4	1,00
VACM/VAIM/VAYM 1.1/2" NPT	16,0	1.1/2" NPT	1.1/2" NPT	105	132,0	104,0	56,00	56,00	63,50	31,75	5,0	2,800
VACM/VAIM/VAYM 1.1/2" BSP	16,0	1.1/2" BSP	1.1/2" BSP	105	132,0	104,0	56,00	56,00	63,50	31,75	5,0	2,800



## VÁLVULAS GLOBO TIPO PONTA DE AGULHA

Série 6000 -Classe de Pressão : Óleo, Água e Gás à 40 °C -6000lbs ou 420kg/m<sup>2</sup>

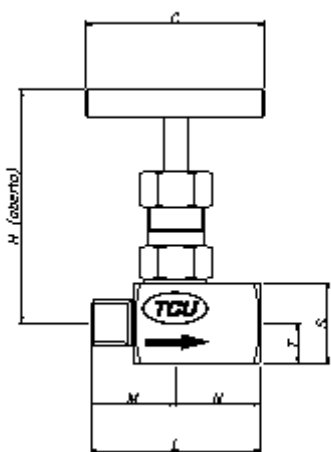

Conexões Macho/Fêmea  
(VACMF/VAIMF/VAYMF)

Código	Passagem	Conexões		C	H	L	M	N	S	T	CV	Peso (kg)
	Efetiva (mm)	Entrada	Saída									
VACMF/VAIMF/VAYMF 1/4" NPT	4,5	1/4" NPT	1/4" NPT	70	79,0	49,5	25,75	23,75	28,57	14,28	0,43	0,430
VACMF/VAIMF/VAYMF 1/4" BSP	4,5	1/4" BSP	1/4" BSP	70	79,0	49,5	25,75	23,75	28,57	14,28	0,43	0,430
VACMF/VAIMF/VAYMF 1/4" SW	4,5	1/4" NPT	1/4" SW	70	79,0	49,5	25,75	23,75	28,57	14,28	0,43	0,430
VACMF/VAIMF/VAYMF 3/8" NPT	5,5	3/8" NPT	3/8" NPT	70	79,0	49,5	25,75	23,75	28,57	14,28	0,65	0,390
VACMF/VAIMF/VAYMF 3/8" BSP	5,5	3/8" BSP	3/8" BSP	70	79,0	49,5	25,75	23,75	28,57	14,28	0,65	0,390
VACMF/VAIMF/VAYMF 3/8" SW	5,5	3/8" NPT	3/8" SW	70	79,0	49,5	25,75	23,75	28,57	14,28	0,65	0,390
VACMF/VAIMF/VAYMF 1/2" NPT	7,0	1/2" NPT	1/2" NPT	70	83,0	60,0	30,00	30,00	31,75	15,87	1,03	0,545
VACMF/VAIMF/VAYMF 1/2" BSP	7,0	1/2" BSP	1/2" BSP	70	83,0	60,0	30,00	30,00	31,75	15,87	1,03	0,545
VACMF/VAIMF/VAYMF 1/2" SW	7,0	1/2" NPT	1/2" SW	70	83,0	60,0	30,00	30,00	31,75	15,87	1,03	0,545
VACMF/VAIMF/VAYMF 3/4" NPT	8,5	3/4" NPT	3/4" NPT	70	97,5	70,0	35,00	35,00	41,27	20,63	1,4	0,980
VACMF/VAIMF/VAYMF 3/4" BSP	8,5	3/4" BSP	3/4" BSP	70	97,5	70,0	35,00	35,00	41,27	20,63	1,4	0,980
VACMF/VAIMF/VAYMF 3/4" SW	8,5	3/4" NPT	3/4" SW	70	97,5	70,0	35,00	35,00	41,27	20,63	1,4	0,980
VACMF/VAIMF/VAYMF 1" NPT	11,0	1" NPT	1" NPT	90	126,0	89,0	44,50	44,50	50,80	25,40	2,4	1,090
VACMF/VAIMF/VAYMF 1" BSP	11,0	1" BSP	1" BSP	90	126,0	89,0	44,50	44,50	50,80	25,40	2,4	1,090
VACMF/VAIMF/VAYMF 1" SW	11,0	1" NPT	1" SW	90	126,0	89,0	44,50	44,50	50,80	25,40	2,4	1,090
VACMF/VAIMF/VAYMF 1.1/2" NPT	16,0	1.1/2" NPT	1.1/2" NPT	105	132,0	104,0	56,00	56,00	63,50	31,75	5,0	2,900
VACMF/VAIMF/VAYMF 1.1/2" BSP	16,0	1.1/2" BSP	1.1/2" BSP	105	132,0	104,0	56,00	56,00	63,50	31,75	5,0	2,900
VACMF/VAIMF/VAYMF 1.1/2" SW	16,0	1.1/2" NPT	1.1/2" SW	105	132,0	104,0	56,00	56,00	63,50	31,75	5,0	2,900



## VÁLVULAS GLOBO TIPO PONTA DE AGULHA

Série 6000 -Classe de Pressão : Óleo, Água e Gás à 40°C -6000lbs ou 420kg/m<sup>2</sup>

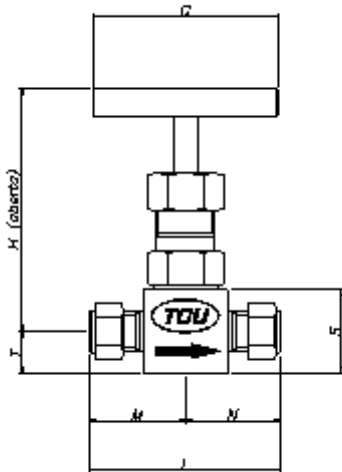

Conexões para Tubo OD  
(VACOD/VAIOD/VAYOD)

Código	Passagem	Conexões		C	H	L	M	N	S	T	CV	Peso (kg)
	Efetiva (mm)	Entrada	Saída									
VACOD/VAIOD/VAYOD 1/8"	2,5	1/8"	1/8"	70	82,0	65	32,5	32,5	25,40	12,70	0,13	0,320
VACOD/VAIOD/VAYOD 3	2,5	3 mm	3 mm	70	82,0	65	32,5	32,5	25,40	12,70	0,13	0,320
VACOD/VAIOD/VAYOD 1/4"	4,0	1/4"	1/4"	70	82,0	65	32,5	32,5	25,40	12,70	0,34	0,350
VACOD/VAIOD/VAYOD 6	4,0	6 mm	6 mm	70	82,0	65	32,5	32,5	25,40	12,70	0,34	0,350
VACOD/VAIOD/VAYOD 3/8"	5,5	3/8"	3/8"	70	82,0	70	35,0	35,0	28,57	14,28	0,65	0,450
VACOD/VAIOD/VAYOD 10	5,5	10 mm	10 mm	70	82,0	70	35,0	35,0	28,57	14,28	0,65	0,450
VACOD/VAIOD/VAYOD 1/2"	7,0	1/2"	1/2"	70	86,5	75,0	37,50	37,50	31,75	15,87	1,03	0,570
VACOD/VAIOD/VAYOD 12	7,0	12 mm	12 mm	70	86,5	75,0	37,50	37,50	31,75	15,87	1,03	0,570





## VÁLVULAS GLOBO TIPO PONTA DE AGULHA

Para obter maiores informações sobre nossos produtos e serviços acesse:

[www.tcuvalvulas.com.br](http://www.tcuvalvulas.com.br)

ou envie um email para:

[comercial@tcuvalvulas.com.br](mailto:comercial@tcuvalvulas.com.br)



### **TCU VÁLVULAS**

Rua Monte Aprazível, 270  
CEP 08595-030 – Itaquaquetuba - SP  
Telefone: (11) 4647 8781